

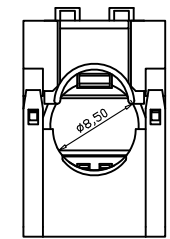

CAT6A Class EA RJ45 plug to be assembled in the field

- FTP TYPE: 1 piece Design
- Easy Assembly - easily terminated in the field in 2 minute without any special tools
- Operation temperature:-40℃ to 60℃, Relative humidity: 85%(30℃), Air pressure: 70-106Kpa.
- Gold Plated Phosphor Bronze Blade: phosphor bronze and gold plating (3~50ininch), mating durability not less than 750 cycles ;
- Anti-burn performance: product made from Kirsite \ PC
- Intermediate resistance: no more than 20m ohm in normal atmosphere pressure (not including bulk resistor) ;
- Insulated resistance: no less than 1,000M ohm in normal atmosphere pressure ;
- Retention strength: 7.7kg between jack and plug.
- Label: clear label to ensure easy to management ;
- Wire Connection: Stranded wire AWG 24/7 to 22/7
- Wire Connection: Solid wire AWG 24/1 to 22/1

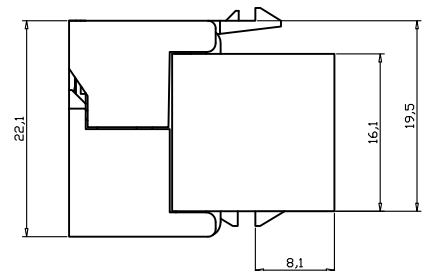
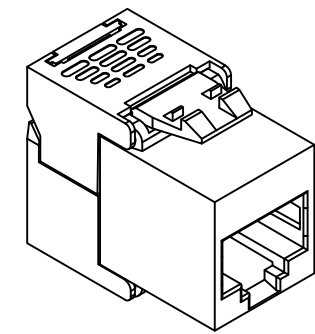
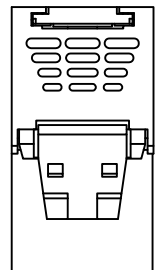
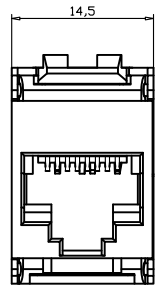
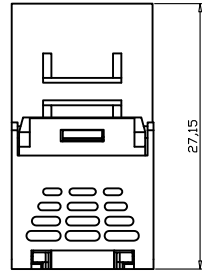
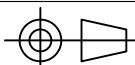

TITLE:			 Shenzhen Copperled Technology Co.,Ltd	
	INCH	MM		
.X	.015	.30	TITLE: FTP Cat.6A Keystone Jack 180 degree	
.XX	.010	.10		
.XXX	.005	.05		
DRAWN BY	MA		P/N: CL-KJ-C6A17	
CHECK BY	SCALE	1:1		REV 1.2
	UNIT	MM		
APPD BY	SHEET	1/1	DWG NO:	
	DATE	2021/11/11		